

# Section H: Line Voltage Lighting



# Line Voltage Quick List



Line Voltage

Disclaimer: Shape, Design, and Finish may change without prior notice.

# Line Voltage Quick List



**P740-HPS70**



**8402**



**8300**



**8330**



**8340**



**VPB2**



**VPP2**



**VPW2**



**VPB3**



**VPP3**



**VPW3**



**P740-26PL**



**HWP12**



**HWP7**



**HWP1**



**HWP2**



**HWP4**



**HWP5**



**HWP8**



**HWP3**



**HWP13**



**HWP15**



**HWP11**



**HWP11U**



**HWP14**



**HWP6**



**HFL1**



**HFL3-MH175**



**HFL2-MH175**



**HFL2S-MH175**



**HFL4**



**HFL5**



**HL38**



**HHB1**



**HHB2**

*More Options and Accessories Available*



**HCM3**



**HCM1**



**HCM2**



*Disclaimer: Shape, Design, and Finish may change without prior notice.*

Line Voltage

# Pagodas

Cast Aluminum

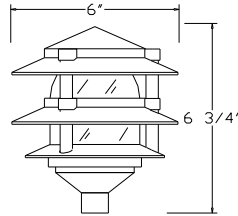

 **2033**

- 120 Volts
- Incandescent A19 Not Included (60W Max.)

 **2037**

- 120 Volts
- PL9Q 9W (Included)

- Cast Aluminum
- 3-Tier
- Frosted Glass Lens, Clear by Request
- 8" Extension Wand

▶ **Finishes:**

- Black
- Bronze
- Green
- Verde Green

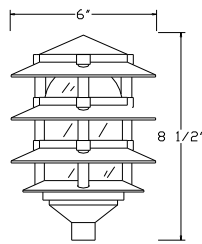

 **2044**

- 120 Volts
- Incandescent A19 Not Included (60W Max.)

 **2047**

- 120 Volts
- PL13Q 13W (Included)

- Cast Aluminum
- 4-Tier
- Frosted Glass Lens, Clear by Request
- 8" Extension Wand

▶ **Finishes:**

- Black
- Bronze
- Green
- Verde Green

Line Voltage

**See Landscape Lighting Section for 12V versions**

*Disclaimer: Shape, Design, and Finish may change without prior notice.*





# 120V

Cast Aluminum

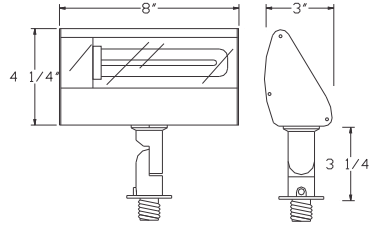

## S613

- Aluminum
- 120 Volts
- PL13 Lamp Included
- Tempered Glass Lens

- ▶ **Powder Coated Finishes:**
- Black
  - Bronze
  - Green
  - White

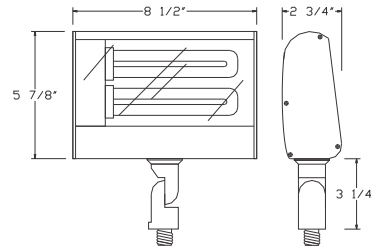

## S626

- Wide Flood
- Aluminum
- 120 Volts
- 2 X PL13 Lamps Included
- Tempered Glass Lens

- ▶ **Powder Coated Finishes:**
- Black
  - Bronze
  - Green
  - White

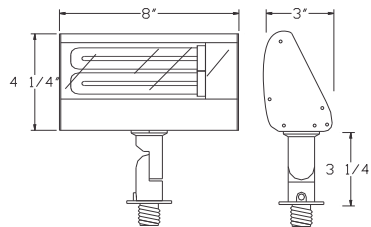

## S626S

- Aluminum
- 120 Volts
- 2 X PL13 Lamps Included
- Tempered Glass Lens

- ▶ **Powder Coated Finishes:**
- Black
  - Bronze
  - White

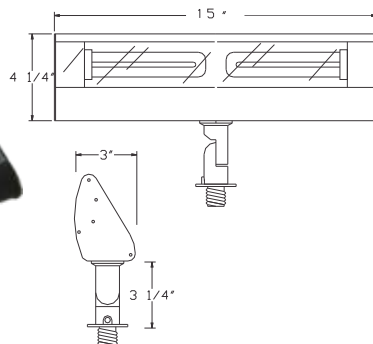

## S626L

- Solid Aluminum
- 120 Volts
- 2 X PL13 Lamps Included
- Tempered Glass Lens

- ▶ **Powder Coated Finishes:**
- Black

Disclaimer: Shape, Design, and Finish may change without prior notice.

Line Voltage

# 120V

**ABS PLASTIC**

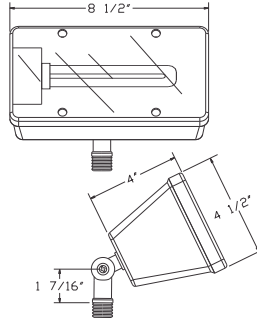

**P613**

- Heavy-Duty ABS Plastic
- 120 Volts
- PL13 Lamp Included
- Acrylic Lens

**Color:**  
• Black

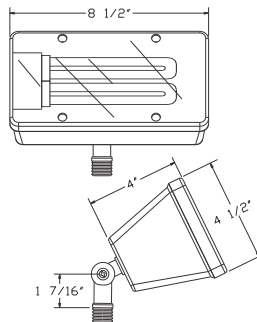

**P626**

- Heavy-Duty ABS Plastic
- 120 Volts
- 2 X PL13 Lamps Included
- Acrylic Lens

**Color:**  
• Black

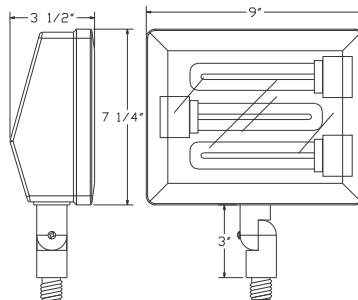

**P639**

- Heavy-Duty ABS Plastic
- 120 Volts
- 3 X PL13 Lamps Included
- Acrylic Lens

**Color:**  
• Black

Line Voltage

Disclaimer: Shape, Design, and Finish may change without prior notice.



# 120V

Cast Aluminum

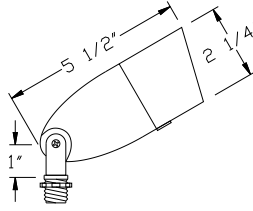

 **HL16**

- Cast Aluminum
- 120 Volts
- Use with PAR16 or JDR16 Lamp Not Included (60W Max.)
- Tempered Glass Lens

- ▶ **Powder Coat Finishes:**
- Black
  - Bronze
  - Green
  - White



JDR16 Lamp (Not Included)  
Refer to Page G48

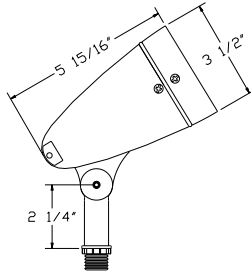

 **HL20**

- Cast Aluminum
- 120 Volts
- PAR20 Lamp (50W Max.) - No Lamp
- Tempered Glass Lens

- ▶ **Powder Coat Finishes:**
- Black
  - Bronze
  - Green
  - White
  - Sand

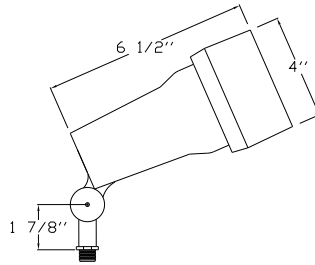

 **HL20S**

- Cast Aluminum
- 120 Volts
- PAR20 Lamp (50W Max.) - No Lamp
- Tempered Glass Lens

- ▶ **Powder Coat Finishes:**
- Black
  - Bronze
  - Green
  - White

FIBERGLASS

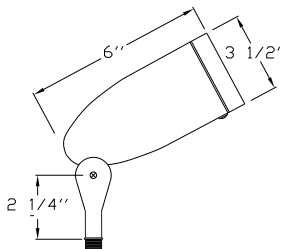

 **FGHL20**

- Fiberglass
- 120 Volts
- PAR20 Lamp (50W Max.) - No Lamp
- Convex Acrylic Lens

- ▶ **Color:**
- Bronze

Line Voltage



# Floodlights

## 120V

Cast Aluminum



Shown in Bronze

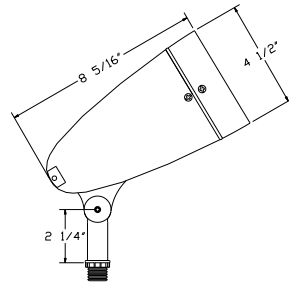

**HL30**

- Cast Aluminum
- 120 Volts
- PAR30 (75W Max.) - No Lamp
- O-Ring, Silicone Gasket
- Tempered Glass Lens

▶ **Powder Coat Finishes:**

- Black
- Bronze
- Green
- White



Shown in Bronze

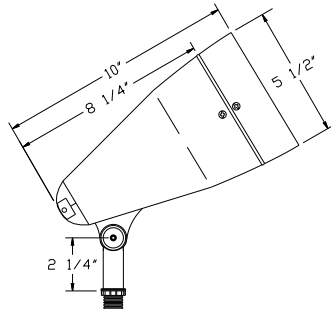

**HL38**

- Cast Aluminum
- 120 Volts
- PAR38 (90W Max.) - No Lamp
- Tempered Glass Lens

▶ **Powder Coat Finishes:**

- Black
- Bronze
- Sand
- Green
- White

### 38V

- Optional Visor for HL38

FIBERGLASS

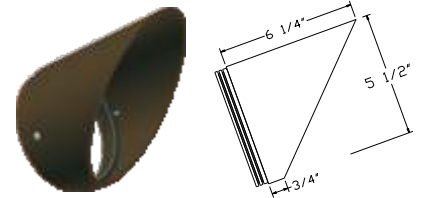
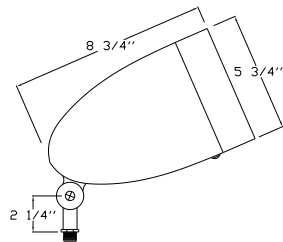

**FGHL38**

- Fiberglass
- 120 Volts
- PAR38 (90W Max.) - No Lamp
- O-Ring, Silicone Gasket
- Tempered Glass Lens

▶ **Color:**

- Bronze

### FG38V

- Optional Visor for FGHL38

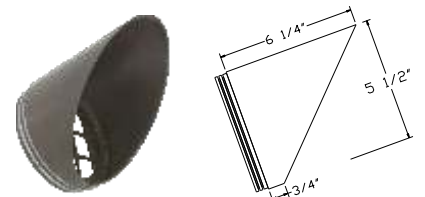

**Optional MR16-3W-LED-EB Upgrade (3W Equivalent to 20W), Sold Separately**

Disclaimer: Shape, Design, and Finish may change without prior notice.

[www.evergreenoutdoor.com](http://www.evergreenoutdoor.com)



or



Line Voltage





**Cast Aluminum**

**120V**



*Shown in Green*

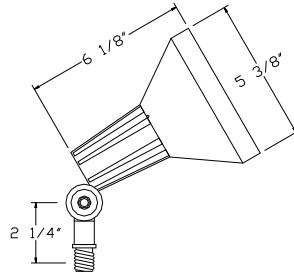

**HL2**

- Cast Aluminum
- 120 Volts
- PAR38 Lamp (90W Max.) - No Lamp
- Silicone Gasket Weateproof Lamp Socket

▶ **Powder Coat Finishes:**

- Black
- Green
- Gray
- White



*Shown in Black*

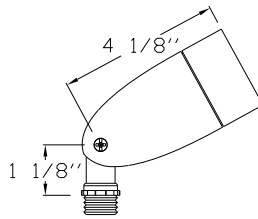

*Shown with Lamp Installed*



**LH90**

- Premium Lamp Holder
- Black Silicon Gasket seals Lamp
- Cast Aluminum
- 120 Volts
- PAR38 (90W Max.) - Not Included

▶ **Finishes:**

- Black
- Bronze
- Gray
- White



*Shown in Gray*

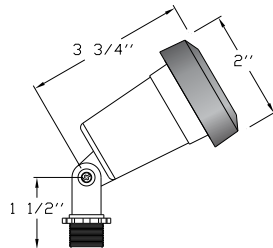

**LH150-SG**

- Cast Aluminum
- 120 Volts
- PAR38 (90W Max.) - Not Included
- Premium Silicon Gasket

▶ **Finishes:**

- Black
- Bronze
- Gray
- White

*Disclaimer: Shape, Design, and Finish may change without prior notice.*

**Line Voltage**

Cast Aluminum

# 120V



Shown in Black

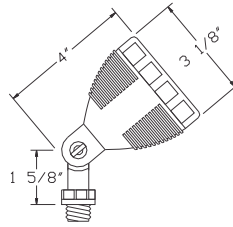

## QR100

- Cast Aluminum
- 120 Volts
- 100W T4 Lamp Included
- Tempered Glass Lens

### ▶ Powder Coat Finishes:

- Black
- Bronze
- Gray
- White



Shown in Bronze

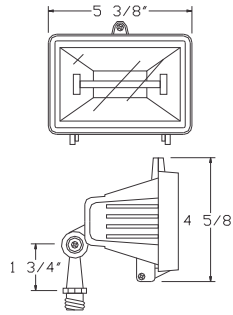

## QH150

- Cast Aluminum
- 120 Volts
- Q150T3/S 150W Lamp Included
- Tempered Glass Lens

### ▶ Powder Coat Finishes:

- Black
- Bronze
- White



Shown in Bronze

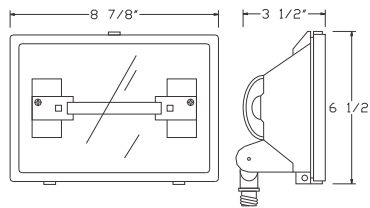

## QH300

- Double Ended T3 300W Lamp Included

## QH500

- Double Ended T3 500W Lamp Included

- Cast Aluminum
- 120 Volt
- Tempered Glass Lens

### ▶ Powder Coat Finishes:

- Black
- Bronze
- White



Shown in Bronze

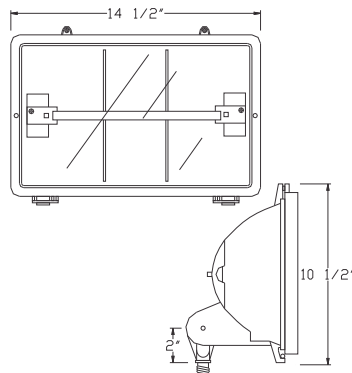

## QH1500

- 120 Volts
- Double Ended 1500W Lamp Included
- Optional Double Ended 1000W Lamp (Sold Separately - See Page G66)

## QH1500-240

- 240 Volts
- Double Ended 1500W Lamp Included

- Cast Aluminum
- Tempered Glass Lens

### ▶ Powder Coat Finishes:

- Bronze

Disclaimer: Shape, Design, and Finish may change without prior notice.

[www.orbitelectric.com](http://www.orbitelectric.com)





Cast Aluminum

**5210**

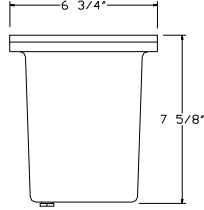

# 120V

**5200 Series**

- Cast Aluminum
- 120 Volts
- PAR38 75W Max. - No Lamp
- Tempered Glass Lens

- ▶ **Powder Coat Finish:**
- Black

**5212**

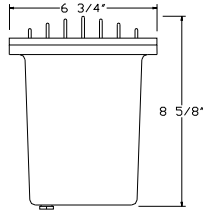

**5X14**

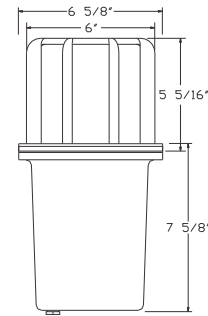

**5213**

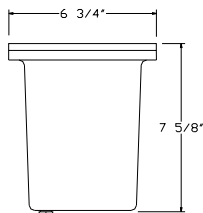

- Dome Only

Line Voltage

**FG5210**



**FG5213**

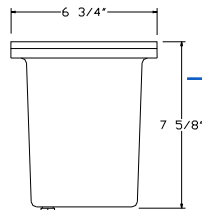

**FG5200 Series**

- Fiberglass
- 120 Volts
- PAR38 75W Max. - No Lamp
- Corrosion-Resistant
- Tempered Glass Lens

- ▶ **Color:**
- Black



**Optional MR16-3W-LED-EB Upgrade (3W Equivalent to 20W), Sold Separately**

*Disclaimer: Shape, Design, and Finish may change without prior notice.*

[www.evergreenoutdoor.com](http://www.evergreenoutdoor.com)

**120~277V**

**Stainless Steel**

 **5610-MH70**

- Stainless Steel Construction in PVC Sleeve
- 120/208/240/277 Input Volts
- Double-Ended 70W Metal Halide
- Lamp Included
- Heavy-Duty Tempered Glass
- Stainless Steel Screws

▶ **Finish:**

- Natural Stainless Steel



*Stainless Steel Construction  
in PVC Sleeve*

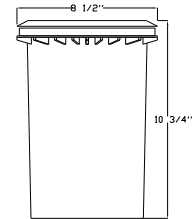

 **5710-MH100 &  
5711-MH100**

- Stainless Steel Construction in PVC Sleeve
- 120/208/240/277 Input Volts
- Double-Ended 100W Metal Halide
- Lamp Included
- Heavy-Duty Tempered Glass
- Stainless Steel Screws

▶ **Finish:**

- Natural Stainless Steel



*Stainless Steel Construction  
in PVC Sleeve*

**5710-MH100**

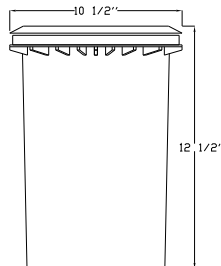

**5711-MH100**

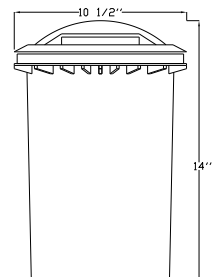

**Line Voltage**

*Disclaimer: Shape, Design, and Finish may change without prior notice.*

[www.orbitelectric.com](http://www.orbitelectric.com)







**120~277V**



**FG5610-MH70 &  
FG5612-MH70**

- Fiberglass
- 120/208/240/277 Input Volts
- Double Ended 70W Metal Halide
- Lamp Included
- Heavy-Duty Tempered Glass
- Stainless Steel Screws

▶ **Color:**  
• Bronze

**FG5610-MH70**

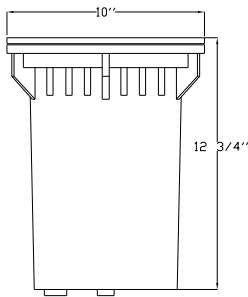

**FG5612-MH70**

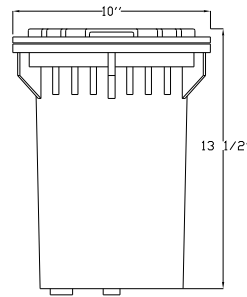

**FIBERGLASS**



**FG5710-MH100 &  
FG5712-MH100**

- Fiberglass
- 120/208/240/277 Input Volts
- Medium Base 100W Metal Halide
- Lamp Included
- Heavy-Duty Tempered Glass
- Stainless Steel Screws

▶ **Color:**  
• Bronze

**FG5710-MH100**

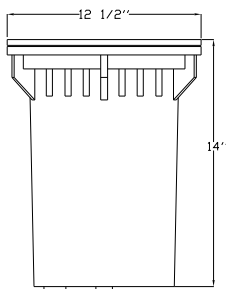

**FG5712-MH100**

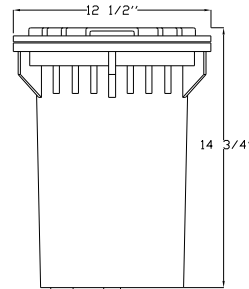

**FIBERGLASS**

**Line Voltage**

Disclaimer: Shape, Design, and Finish may change without prior notice.

[www.orbitelectric.com](http://www.orbitelectric.com)

## Step Lights

### Coverplates

**7210C**

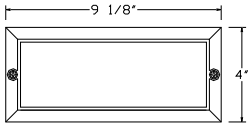

**7212C**

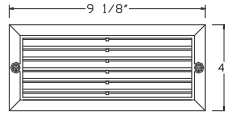

**7312C**

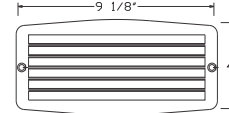

- Cast Aluminum
- Frosted Glass Lens

- ▶ **Powder Coat Finishes:**
- Black
  - Bronze
  - White

**Order Housing & Coverplate Separately**

### Housing Options

# 120V



**7210H-E26**

- Powder Coated Cast Aluminum
- Sealing Gasket
- 120 Volts - 40W Max.
- Medium Base Socket - No Lamp
- Fits Any of the Coverplates Above

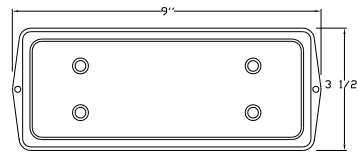

**7210H-PL9**

- Powder Coated Cast Aluminum
- Sealing Gasket
- 120 Volts - 9W
- PL9 Included
- Fits Any of the Coverplates Above

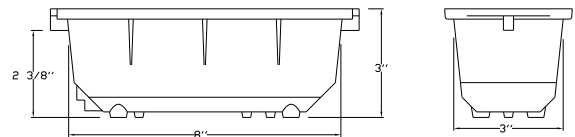



### Coverplates

# S710 Series 120V

**S710C**

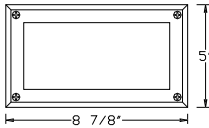

**S711C**

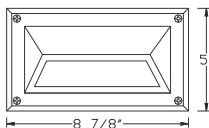

**S712C**

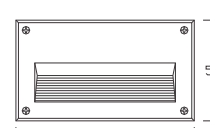

**S713C**

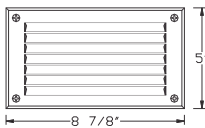

- Cast Aluminum
- Frosted Glass Lens
- ▶ **Powder Coat Finishes:**
  - Black
  - Bronze
  - White

**Order Housing & Coverplate Separately**

### Housing Options

Line Voltage



**S710H-E26**

- Powder Coated Cast Aluminum
- 120 Volts - 40W
- Sealing Gasket
- Medium Base Socket - No Lamp



**S710H-PL9**

- Powder Coated Cast Aluminum
- 120 Volts - 9W
- Sealing Gasket
- PL9Q Lamp Included

**S710H-LED-120V**

- Powder Coated Cast Aluminum
- Sealing Gasket
- S710H-LED-120V  
120 Volts  
60 Lamps @ .064W Each  
Allow Total 9.6W Input



**S710H-PL13**

- Powder Coated Cast Aluminum
- 120 Volts - 13W
- Sealing Gasket
- PL13Q Lamp Included

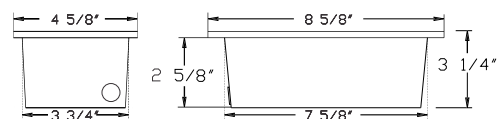

Disclaimer: Shape, Design, and Finish may change without prior notice.

[www.orbitelectric.com](http://www.orbitelectric.com)

## Bulkheads

# Cast Aluminum

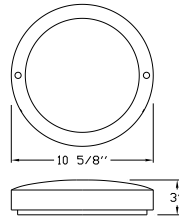

### **7910-A19**

- 120 Volts
- Medium Base Socket N/L (60W Max.)

### **7910-13PL**

### **7910-26PL**

- Cast Aluminum
- 120 Volts
- 1 or 2 PL13Q Lamp(s) Included
- Frosted Glass Lens
- ▶ **Powder Coat Finish:**
  - White

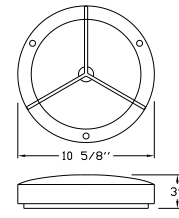

### **7912-A19**

- 120 Volts
- Medium Base Socket N/L (60W Max.)

### **7912-13PL**

### **7912-26PL**

- Cast Aluminum
- 120 Volts
- 1 or 2 PL13Q Lamp(s) Included
- Frosted Glass Lens
- ▶ **Powder Coat Finish:**
  - White

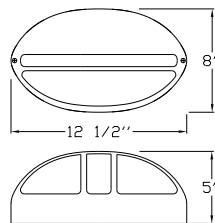

### **7711-A19**

- 120 Volts
- Medium Base Socket N/L (100W Max.)

### **7711-13PL**

### **7711-26PL**

- Cast Aluminum
- 120 Volts
- 1 or 2 PL13 Lamp(s) Included
- Opal Polycarbonate Lens
- ▶ **Powder Coat Finish:**
  - White

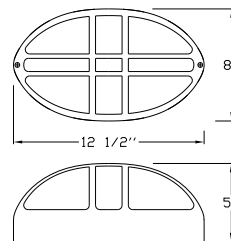

### **7712-A19**

- 120 Volts
- Medium Base Socket N/L (100W Max.)

### **7712-13PL**

### **7712-26PL**

- Cast Aluminum
- 120 Volts
- 1 or 2 PL13 Lamp(s) Included
- Opal Polycarbonate Lens
- ▶ **Powder Coat Finish:**
  - White

Line Voltage

Disclaimer: Shape, Design, and Finish may change without prior notice.

[www.orbitelectric.com](http://www.orbitelectric.com)







# Cast Aluminum

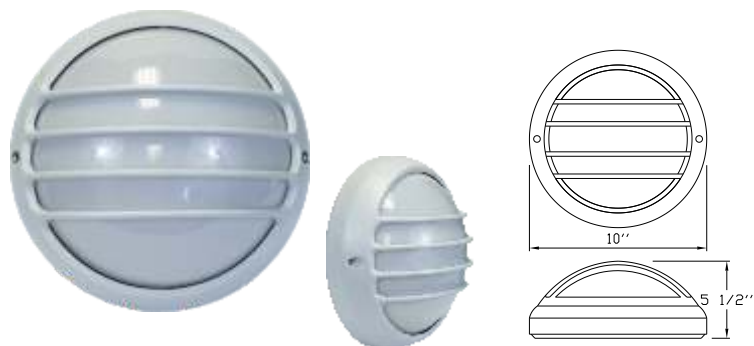

### **7812-A19**

- 120 Volts
- Medium Base Socket N/L (100W Max.)

### **7812-13PL**

### **7812-26PL**

- Cast Aluminum
- 120 Volts
- 1 or 2 PL13Q Lamp(s) Included
- Opal Polycarbonate Lens
- ▶ **Powder Coat Finish:**
  - White



### **7815-A19**

- 120 Volts
- Medium Base Socket N/L (100W Max.)

### **7815-13PL**

### **7815-26PL**

- Cast Aluminum
- 120 Volts
- 1 or 2 PL13Q Lamp(s) Included
- Frosted Glass Lens
- ▶ **Powder Coat Finish:**
  - White



### **7816-A19**

- 120 Volts
- Medium Base Socket N/L (100W Max.)

### **7816-13PL**

### **7816-26PL**

- Cast Aluminum
- 120 Volts
- 1 or 2 PL13Q Lamp(s) Included
- Frosted Glass Lens
- ▶ **Powder Coat Finish:**
  - White



### **7817-A19**

- 120 Volts
- Medium Base Socket N/L (100W Max.)

### **7817-13PL**

### **7817-26PL**

- Cast Aluminum
- 120 Volts
- 1 or 2 PL13Q Lamp(s) Included
- Frosted Glass Lens
- ▶ **Powder Coat Finishes:**
  - White
  - Bronze

# Line Voltage

Disclaimer: Shape, Design, and Finish may change without prior notice.

[www.orbitelectric.com](http://www.orbitelectric.com)

## Bulkheads

# Cast Aluminum

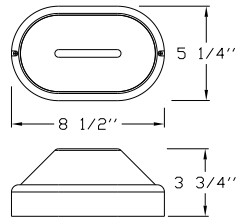

**7603-A19**

- 120 Volts
- Medium Base Socket N/L (100W Max.)

**7603-13PLQ**

- Cast Aluminum
- 120 Volts
- PL13Q Lamp Included
- Frosted Glass Lens

▶ **Powder Coat Finish:**

- White

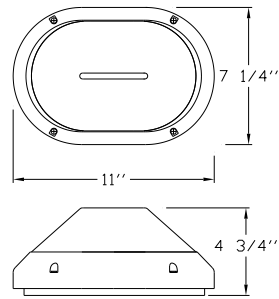

**7613-A19**

- 120 Volts
- Medium Base Socket N/L (100W Max.)

**7613-13PL**

- Cast Aluminum
- 120 Volts
- PL13 Lamp Included
- Frosted Glass Lens

▶ **Powder Coat Finish:**

- White

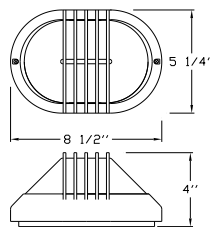

**7604-A19**

- 120 Volts
- Medium Base Socket N/L (100W Max.)

**7604-13PLQ**

- Cast Aluminum
- 120 Volts
- PL13Q Lamp Included
- Frosted Glass Lens

▶ **Powder Coat Finish:**

- White

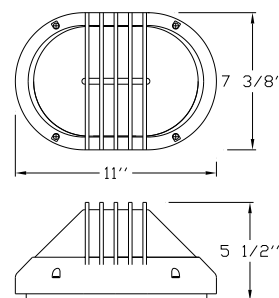

**7614-A19**

- 120 Volts
- Medium Base Socket N/L (100W Max.)

**7614-13PL**

- Cast Aluminum
- 120 Volts
- PL13 Lamp Included
- Frosted Glass Lens

▶ **Powder Coat Finish:**

- White

Line Voltage



**Cast Aluminum**

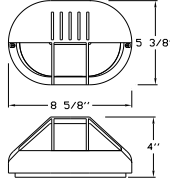

**7605-A19**

- 120 Volts
- Medium Base Socket N/L (60W Max.)



**7605-13PLQ**

- Cast Aluminum
- 120 Volts
- PL13Q Lamp Included
- Frosted Glass Lens

▶ **Powder Coat Finish:**

- White

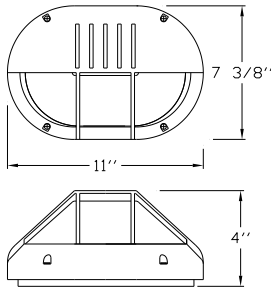

**7615-A19**

- 120 Volts
- Medium Base Socket N/L (100W Max.)



**7615-13PL**

- Cast Aluminum
- 120 Volts
- PL13 Lamp Included
- Frosted Glass Lens

▶ **Powder Coat Finish:**

- White

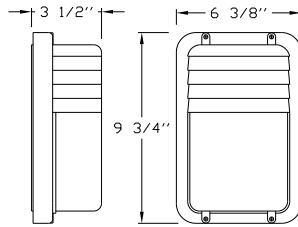

**7606-A19**

- 120 Volts
- Medium Base Socket N/L (60W Max.)



**7606-13PL**

- Cast Aluminum
- 120 Volts
- PL13 Lamp Included
- Opal Polycarbonate Lens

▶ **Powder Coat Finishes:**

- White
- Bronze

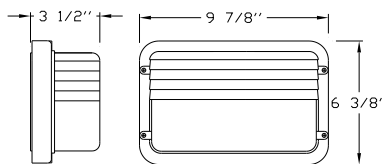

**7607-A19**

- 120 Volts
- Medium Base Socket N/L (60W Max.)



**7607-13PL**

- Cast Aluminum
- 120 Volts
- PL13 Lamp Included
- Opal Polycarbonate Lens

▶ **Powder Coat Finishes:**

- White
- Bronze

**Line Voltage**

**ABS PLASTIC**

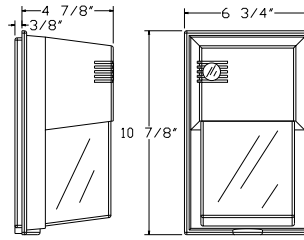

### P740-HPS70

- Cast Aluminum Back Plate
- ABS Housing
- Acrylic Lens
- 120 Volts
- HPS 70W Lamp Included
- Integrated Photocell

▶ **Available Colors:**

- Bronze
- White

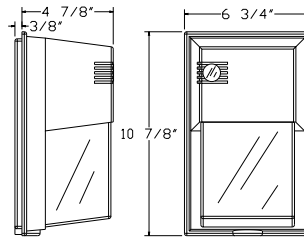

### P740-26PL

- Cast Aluminum Back Plate
- ABS Housing
- Acrylic Lens
- 120 Volts
- 2 X PL13 26W (Included) Magnetic Ballast
- Integrated Photocell
- Acrylic Lens

▶ **Available Colors:**

- Bronze
- White

Line Voltage





**Cast Aluminum**



**8300**

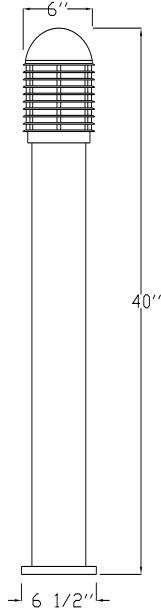

**8402**

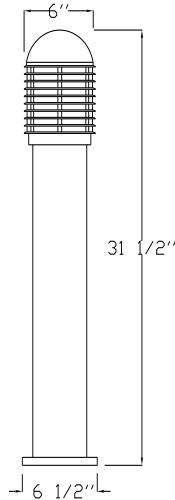

**Standard Series**

- Cast Aluminum
- Opal Polycarbonate Lens
- Medium Base Socket - No Lamp
- **HID Ready - Select a Conversion Kit**
- Includes Mounting Hardware and Anchors

► **Finishes:**

- Black
- Bronze

**Metal Halide & Compact Fluorescent Conversion Kits**

**Line Voltage**

**Specs**

- These kits are self-contained with all necessary components including lamp and socket.
- Select a kit to convert any of the Bollards in minutes; Slips easily into the fixture.

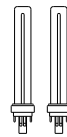

**8300-PL26-KIT**

(For 8300 & 8402 Only)

- 120V Input Magnetic Ballast
- 2 X PL13 Sockets and Lamps Included



**8300-MH70-KIT**

- 120V - 277V Input
- 70W Medium Base Metal Halide Lamp Included
- Uses Existing Socket in Fixture

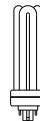

**8300-PL26E-KIT**

- 120/277V Input Electronic Ballast
- PL26Q Socket and Lamp Included



**8300-MH100-KIT**

- 120V - 277V Input
- 100W Medium Base Metal Halide Lamp Included
- Uses Existing Socket in Fixture

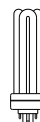

**8300-PL42-KIT**

- 120V Input
- PL42Q Socket and Lamp Included

*Disclaimer: Shape, Design, and Finish may change without prior notice.*

[www.orbitelectric.com](http://www.orbitelectric.com)

# Specification Grade Bollards

**Cast Aluminum**



**8330**

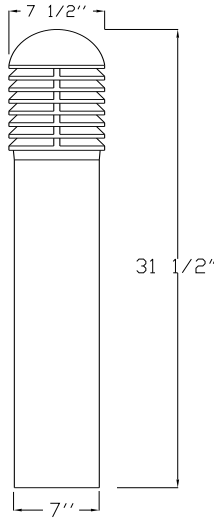

**Spec. Series**

- Heavy-Duty Cast Aluminum
- 6 Levels of Tempered Glass Tiers Create a Unique Light Output
- Medium Base Socket - No Lamp
- Includes Mounting Hardware and Anchors

- ▶ **Finishes:**
- Black
  - Bronze

**See Conversion Kits on page H18**

**Except: 8300-PL26-KIT**



**8340**

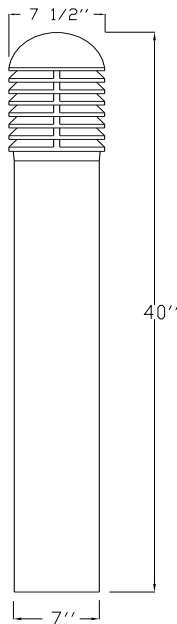

**Line Voltage**



**150 Watt - Small Jar**

**Description:**

- A21 Medium Base Socket (No Lamp)
- 150W Max.
- Clear Glass Jar
- Die-Cast Aluminum with Die-Cast Guard
- 1/2" NPS Hub Size

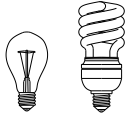

**VPB2**

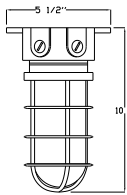

**VPP2**

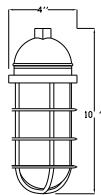

**VPW2**

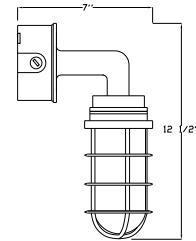

**300 Watt - Large Jar**

**Description:**

- PS25 Medium Base Socket (No Lamp)
- 300W Max.
- Clear Glass Jar
- Die-Cast Aluminum with Die-Cast Guard
- 1/2" NPS Hub Size

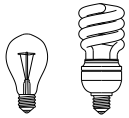

**VPB3**

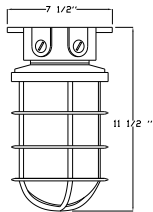

**VPP3**

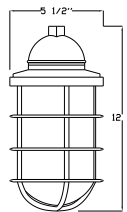

**VPW3**

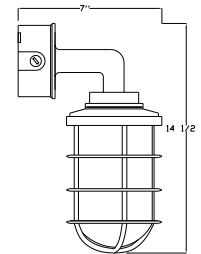

**Wallpacks**

Cat. No. : **HWP12-HPS150 120V**  
 Ballast : 120V with Reactor Ballast NPF  
 Lamp : High-Pressure Sodium (HPS) 150W,  
 16000 Lumens, 22 CRI Color Rendition

Cat. No. : **HWP12-MH175-PS (Pulse Start)**  
**\*HWP12-MH175 120~277V**  
 Ballast : 120/208/240/277V  
 Quad Tap CWA HPF  
 Lamp : Metal Halide (MH) 175W,  
 11700 Lumens, 65 CRI Color Rendition

Cat. No. : **WG-12**  
 Description : Optional Wire Guard for HWP12  
 Stainless Steel



*Shown Installed*

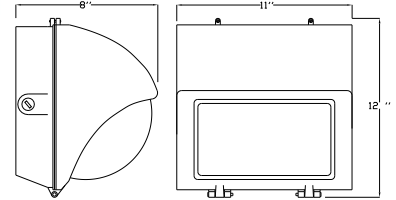

**Features:**

- Semi-Cutoff Design
- Borosilicate Molded Glass Lens
- Cast Aluminum Housing
- Textured Bronze Finish
- Hinged Front Housing for Easy Relamping
- Medium-Base Socket
- 1/2-inch NPS tapped back and two sides for conduit entrances
- Lamp Included in both Models
- Suitable for Wet Locations



Cat. No. : **HWP7-PL84 120/227V**  
 Ballast : 120/227V Electronic  
 Lamp : 2 X PL42 (4-Pin, GX24Q-4 Socket) 42W,  
 Lamp Included  
 3000 Lumens, 82 CRI Color Rendition

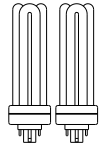

**Features:**

- Euro-Style Fluorescent Wall Pack
- Die-Cast Aluminum Back Housing, Textured Bronze Finish
- Vandal-Resistant Color-Matched Polycarbonate Front Housing
- Clear Polycarbonate Ribbed Lens
- Aluminum Reflector
- Hinged Front Housing for Easy Relamping
- Suitable for Wet Locations

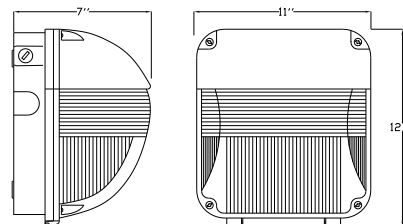

\*While Supplies Last

Disclaimer: Shape, Design, and Finish may change without prior notice.





Cat. No. : **HWP1-HPS70** **120V**  
 Ballast : 120V NPF  
 Lamp : High-Pressure Sodium (HPS) 70W,  
 6400 Lumens, 22 CRI Color Rendition



Cat. No. : **HWP1-MH100** **120~277V**  
 Ballast : 120/208/240/277V  
 Quad Tap HX Ballast MPF  
 Lamp : Metal Halide (MH) 100W,

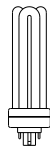

Cat. No. : **HWP1-PL42** **120/277V**  
 Ballast : 120/227V Electronic  
 Lamp : PL42 (4-Pin, GX24Q-4 Socket) 42W,  
 Lamp Included  
 3000 Lumens, 82 CRI Color Rendition

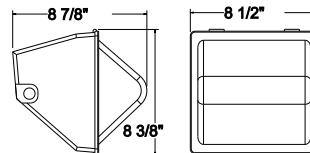

**Features:**

- Clear Polycarbonate Lens with Gasket with UV inhibitors to protect from yellowing
- Cast Aluminum Housing
- Textured Bronze Finish
- Medium-Base Socket for HPS & MH Models
- Fluorescent Socket and Bracket for 42W PL Model
- 1/2-inch NPS tapped back and two sides for conduit entrances
- Lamp Included in both Models
- Suitable for Wet Locations



Cat. No. : **HWP2-HPS150** **120V**  
 Ballast : 120V NPF  
 Lamp : High-Pressure Sodium (HPS) 150W,  
 16000 Lumens, 22 CRI Color Rendition



Cat. No. : **HWP2-MH175-PS** (Pulse Start)  
**\*HWP2-MH175** **120~277V**  
 Ballast : 120/208/240/277V  
 Quad Tap CWA HPF  
 Lamp : Metal Halide (MH) 175W,  
 11700 Lumens, 65 CRI Color Rendition

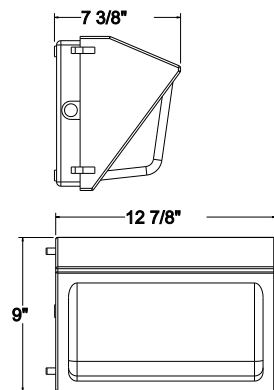

Cat. No. : **FCS-2**  
 Description : Optional Full Cutoff Shroud for HWP2  
 Stamped Aluminum



**Features:**

- Borosilicate Molded Glass Lens
- Cast Aluminum Housing
- Textured Bronze Finish
- Medium-Base Socket
- 1/2-inch NPS tapped back and two sides for conduit entrances
- Lamp Included in both Models
- Suitable for Wet Locations

Cat. No. : **WG-2**  
 Description : Optional Wire Guard for HWP2  
 Stainless Steel



*\*While Supplies Last*

*Disclaimer: Shape, Design, and Finish may change without prior notice.*

# Wallpacks

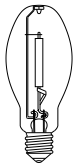

Cat. No. : **HWP4-HPS250 120~277V**

Ballast : 120/208/240/277V  
Quad Tap CWA HPF  
Lamp : High-Pressure Sodium (HPS) 250W,  
28000 Lumens, 22 CRI Color Rendition

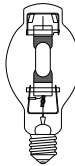

Cat. No. : **HWP4-MH250-PS (Pulse Start)**  
**\*HWP4-MH250 120~277V**

Ballast : 120/208/240/277V  
Quad Tap CWA HPF  
Lamp : Metal Halide (MH) 250W,  
19100 Lumens, 65 CRI Color Rendition

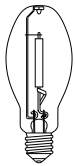

Cat. No. : **HWP5-HPS400 120~277V**

Ballast : 120/208/240/277V  
Quad Tap CWA HPF  
Lamp : High-Pressure Sodium (HPS) 400W,  
51000 Lumens, 22 CRI Color Rendition

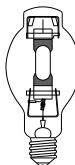

Cat. No. : **HWP5-MH400-PS (Pulse Start)**  
**\*HWP5-MH400 120~277V**

Ballast : 120/208/240/277V  
Quad Tap CWA HPF  
Lamp : Metal Halide (MH) 400W,  
33100 Lumens, 65 CRI Color Rendition



HWP4



HWP5

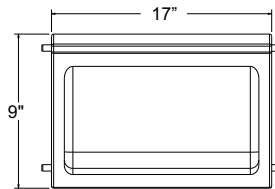
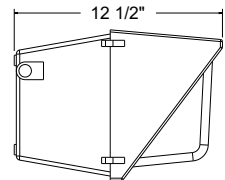
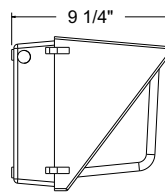

HWP4

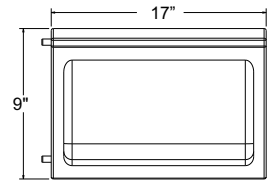

HWP5

Cat. No. : **FCS-4**

Description : Optional Full Cut Shroud for HWP4  
and HWP5  
Stamped Steel



Shown Installed

Cat. No. : **WG-4**

Description : Optional Wire Guard for HWP4  
and HWP5  
Stainless Steel



Shown Installed

**Features:**

- Borosilicate Molded Glass Lens
- Cast Aluminum Housing
- Textured Bronze Finish
- Mogul-Base Socket
- 1/2-inch NPS tapped back and two sides for conduit entrances
- Lamp Included in all Models
- Suitable for Wet Locations



\*While Supplies Last

Disclaimer: Shape, Design, and Finish may change without prior notice.

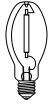

Cat. No. : **HWP8-HPS150** **120V**  
 Ballast : 120V NPF  
 Lamp : High-Pressure Sodium (HPS) 150W,  
 16000 Lumens, 22 CRI Color Rendition



Cat. No. : **HWP8-MH175-PS** (Pulse Start)  
**\*HWP8-MH175** **120~277V**  
 Ballast : 120/208/240/277V  
 Quad Tap CWA HPF  
 Lamp : Metal Halide (MH) 175W,  
 11700 Lumens, 65 CRI Color Rendition

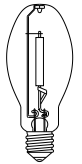

Cat. No. : **HWP8W-HPS250** **120~277V**  
 Ballast : 120/208/240/277V  
 Quad Tap CWA HPF  
 Lamp : High-Pressure Sodium (HPS) 250W,  
 28000 Lumens, 22 CRI Color Rendition

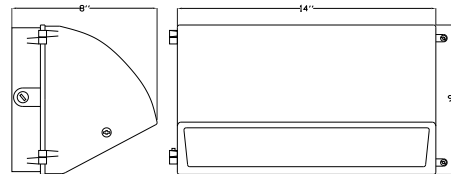

HWP8

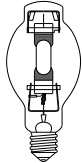

Cat. No. : **HWP8W-MH250-PS** (Pulse Start)  
**\*HWP8W-MH250** **120~277V**  
 Ballast : 120/208/240/277V  
 Quad Tap CWA HPF  
 Lamp : Metal Halide (MH) 250W,  
 19100 Lumens, 65 CRI Color Rendition

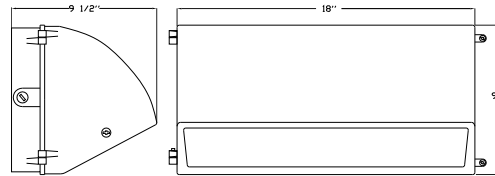

HWP8W

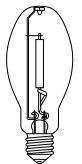

Cat. No. : **HWP8D-HPS400** **120~277V**  
 Ballast : 120/208/240/277V  
 Quad Tap CWA HPF  
 Lamp : High-Pressure Sodium (HPS) 400W,  
 51000 Lumens, 22 CRI Color Rendition

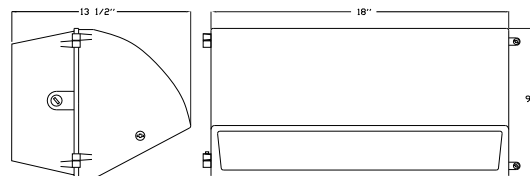

HWP8D

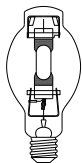

Cat. No. : **HWP8D-MH400-PS** (Pulse Start)  
**\*HWP8D-MH400** **120~277V**  
 Ballast : 120/208/240/277V  
 Quad Tap CWA HPF  
 Lamp : Metal Halide (MH) 400W,  
 33100 Lumens, 65 CRI Color Rendition

**Features:**

- **Semi-Cutoff Design**
- Tempered Clear Glass Lens
- Cast Aluminum Housing
- Textured Bronze Finish
- Hinged Front Housing for Easy Relamping
- Medium-Base Socket for 150W and 175W Models
- Mogul-Base Socket for 250W and 400W Models
- 1/2-inch NPS tapped back and two sides for conduit entrances
- Lamp Included in all Models
- Suitable for Wet Locations



**Wallpacks**

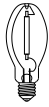

Cat. No. : **HWP3-HPS150** 120~277V

Ballast : 120/208/240/277V  
Quad Tap CWA HPF  
Lamp : High-Pressure Sodium (HPS) 250W,  
28000 Lumens, 22 CRI Color Rendition



Cat. No. : **HWP3-MH175-PS** (Pulse Start)  
**\*HWP3-MH175** 120~277V

Ballast : 120/208/240/277V  
Quad Tap CWA HPF  
Lamp : Metal Halide (MH) 175W,  
11700 Lumens, 65 CRI Color Rendition

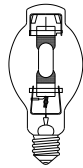

Cat. No. : **HWP3W-MH250-PS** (Pulse Start)  
**\*HWP3W-MH250** 120~277V

Ballast : 120/208/240/277V  
Quad Tap CWA HPF  
Lamp : Metal Halide (MH) 250W,  
19100 Lumens, 65 CRI Color Rendition

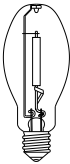

Cat. No. : **HWP3W-HPS250** 120V

Ballast : 120/208/240/277V  
Quad Tap CWA HPF  
Lamp : High-Pressure Sodium (HPS) 250W,  
28000 Lumens, 22 CRI Color Rendition

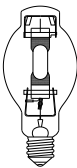

Cat. No. : **HWP3D-MH400-PS** (Pulse Start)  
**\*HWP3D-MH400** 120~277V

Ballast : 120/208/240/277V  
Quad Tap CWA HPF  
Lamp : Metal Halide (MH) 400W,  
33100 Lumens, 65 CRI Color Rendition

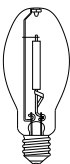

Cat. No. : **HWP3D-HPS400** 120~277V

Ballast : 120/208/240/277V  
Quad Tap CWA HPF  
Lamp : High-Pressure Sodium (HPS) 400W,  
51000 Lumens, 22 CRI Color Rendition

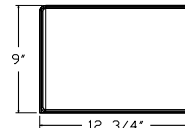
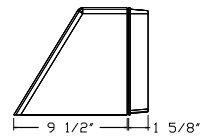

HWP3

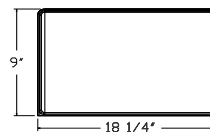
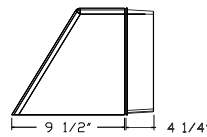

HWP3W

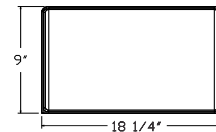
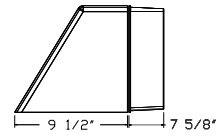

HWP3D

**Features:**

- Tempered Clear Glass Lens
- Cast Aluminum Housing
- Textured Bronze Finish
- Medium-Base Socket for MH175 Model
- Mogul-Base Socket for 250W and 400W Models
- 1/2-inch NPS tapped back and two sides for conduit entrances
- Lamp Included in both Models



\*While Supplies Last

Disclaimer: Shape, Design, and Finish may change without prior notice.





Cat. No. : **HWP13-MH175-PS** (Pulse Start)  
**\*HWP13-MH175** 120~277V



Voltage : 120/208/240/277V  
Quad Tap CWA HPF  
Lamp : Metal Halide (MH) 175W,  
11700 Lumens, 65 CRI Color Rendition



Cat. No. : **HWP13-PL84** 120/277V

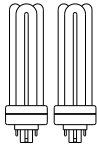

Ballast : 120/277V Electronic  
Lamp : 2 X PL42 (4-Pin, GX24Q-4 Socket) 42W,  
6000 Lumens, 82 CRI Color Rendition

**Features:**

- Tempered Clear Glass Lens
- Cast Aluminum Housing
- Textured Bronze Finish
- Medium-Base Socket for MH175 Model
- Mogul-Base Socket for 250W and 400W Models
- 1/2-inch NPS tapped back and two sides for conduit entrances
- Lamp Included in both Models

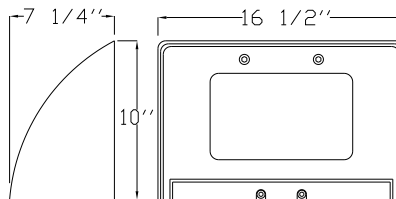

Cat. No. : **HWP15-HPS150** 120V

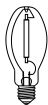

Ballast : 120V NPF  
Lamp : High-Pressure Sodium (HPS) 150W,  
16000 Lumens, 22 CRI Color Rendition

Cat. No. : **HWP15-MH175-PS** (Pulse Start)  
**\*HWP15-MH175** 120~277V



Ballast : 120/208/240/277V  
Quad Tap CWA HPF  
Lamp : Metal Halide (MH) 175W,  
11700 Lumens, 65 CRI Color Rendition



Cat. No. : **HWP15-PL84** 120/277V

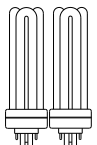

Ballast : 120/277V Electronic  
Lamp : 2 X PL42 (4-Pin, GX24Q-4 Socket) 42W,  
6000 Lumens, 82 CRI Color Rendition

**Features:**

- **Crescent Wall Sconces**
- Tempered Clear Glass Lens
- Cast Aluminum Housing
- Medium-Base Socket for HPS & MH Models
- 1/2-inch NPS tapped back and two sides for conduit entrances
- Lamp Included in All Models

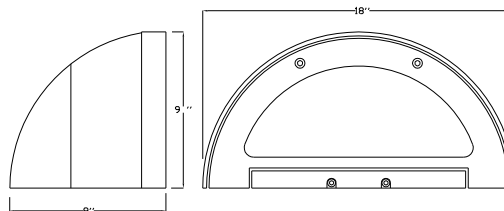

# Wallpacks

Cat. No. : **HWP11-HPS150** 120V



Ballast : 120V NPF  
Lamp : High-Pressure Sodium (HPS) 150W,  
16000 Lumens, 22 CRI Color Rendition

Cat. No. : **HWP11-MH175-PS** (Pulse Start)  
**\*HWP11-MH175** 120~277V



Ballast : 120/208/240/277V  
Quad Tap CWA HPF  
Lamp : Metal Halide (MH) 175W,  
11700 Lumens, 65 CRI Color Rendition

Cat. No. : **HWP11-PL42** 120/277V

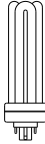

Ballast : 120/277V Electronic  
Lamp : PL42 (4-Pin, GX24Q-4 Socket) 42W,  
3000 Lumens, 82 CRI Color Rendition



**Down Light**

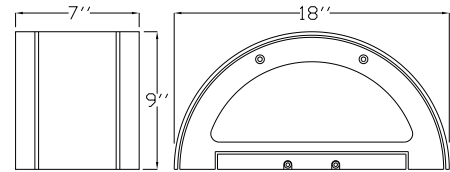

Cat. No. : **HWP11U-HPS150** 120V



Ballast : 120V NPF  
Lamp : High-Pressure Sodium (HPS) 150W,  
16000 Lumens, 22 CRI Color Rendition

Cat. No. : **HWP11U-MH175-PS** (Pulse Start)  
**\*HWP11U-MH175** 120~277V



Ballast : 120/208/240/277V  
Quad Tap CWA HPF  
Lamp : Metal Halide (MH) 175W,  
11700 Lumens, 65 CRI Color Rendition

Cat. No. : **HWP11U-PL42** 120/277V

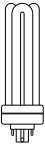

Ballast : 120/277V Electronic  
Lamp : PL42 (4-Pin, GX24Q-4 Socket) 42W,  
3000 Lumens, 82 CRI Color Rendition



**Up and Down Light**

### Available Finishes:



Bronze



Black



White

### Features:

- Crescent Wall Sconces
- Tempered Clear Glass Lens
- Cast Aluminum Housing
- Medium-Base Socket for HPS & MH Models
- 1/2-inch NPS tapped back and two sides for conduit entrances
- Lamp Included in All Models





Cat. No. : **HWP14-HPS150** **120V**  
 Ballast : 120V NPF  
 Lamp : High-Pressure Sodium (HPS) 150W,  
 16000 Lumens, 22 CRI Color Rendition



Cat. No. : **HWP14-MH175-PS** (Pulse Start)  
**\*HWP14-MH175** **120~277V**  
 Ballast : 120/208/240/277V  
 Quad Tap CWA HPF  
 Lamp : Metal Halide (MH) 175W,  
 11700 Lumens, 65 CRI Color Rendition

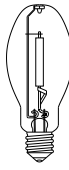

Cat. No. : **HWP14-HPS400** **120~277V**  
 Ballast : 120/208/240/277V  
 Quad Tap CWA HPF  
 Lamp : High-Pressure Sodium (HPS) 400W,  
 51000 Lumens, 22 CRI Color Rendition

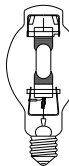

Cat. No. : **HWP14-MH400-PS** (Pulse Start)  
**HWP14-MH400** **120~277V**  
 Ballast : 120/208/240/277V  
 Quad Tap CWA HPF  
 Lamp : Metal Halide (MH) 400W,  
 33100 Lumens, 65 CRI Color Rendition



**Features:**

- Dual Purpose Adjustable Area Light / Wall Pack
- Adjustable Angle from 0° to 30°
- Tempered Clear Glass Lens
- Cast Aluminum Housing
- Textured Bronze Finish
- Hinged Front Housing for Easy Relamping
- Medium-Base Socket for 150W and 175W Models
- Mogul-Base Socket for 400W Models
- 1/2-inch NPS tapped back and two sides for conduit entrances
- Lamp Included in all Models
- Suitable for Wet Locations



**H.I.D. Lighting**

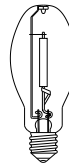

Cat. No. : **HWP6-HPS400** **120~277V**  
 Ballast : 120/208/240/277V  
 Quad Tap CWA HPF  
 Lamp : High-Pressure Sodium (HPS) 400W,  
 51000 Lumens, 22 CRI Color Rendition

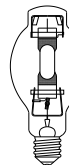

Cat. No. : **HWP6-MH400-PS** (Pulse Start)  
**\*HWP6-MH400** **120~277V**  
 Ballast : 120/208/240/277V  
 Quad Tap CWA HPF  
 Lamp : Metal Halide (MH) 400W,  
 33100 Lumens, 65 CRI Color Rendition

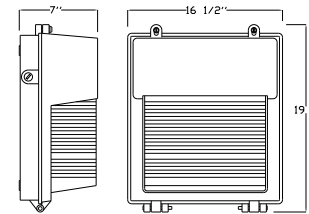

Cat. No. : **WG-6**  
 Description : Optional Wire Guard for HWP6  
 Stainless Steel

**Features:**

- Slim Line Wall Pack
- Borosilicate Molded Glass Lens
- Cast Aluminum Housing
- Textured Bronze Finish
- Mogul-Base Socket
- 1/2-inch NPS tapped back and two sides for conduit entrances
- Lamp Included in both Models
- Suitable for Wet Locations



WG-6  
Shown Installed



# Flood Lights

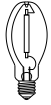

Cat. No. : **HFL1-HPS70** **120V**  
 Ballast : 120V NPF  
 Lamp : High-Pressure Sodium (HPS) 70W,  
 6400 Lumens, 22 CRI Color Rendition

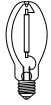

Cat. No. : **HFL1-HPS150** **120V**  
 Ballast : 120V NPF  
 Lamp : High-Pressure Sodium (HPS) 150W,  
 16000 Lumens, 22 CRI Color Rendition



Cat. No. : **HFL1-MH70** **120~277V**  
 Ballast : 120/208/240/277V  
 Quad Tap HX Ballast MPF  
 Lamp : Metal Halide (MH) 70W,  
 5040 Lumens, 65 CRI Color Rendition

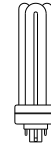

Cat. No. : **HFL1-PL42** **120/227V**  
 Ballast : 120/277V Electronic  
 Lamp : PL42 (4-Pin, GX24Q-4 Socket) 42W,  
 3000 Lumens, 82 CRI Color Rendition

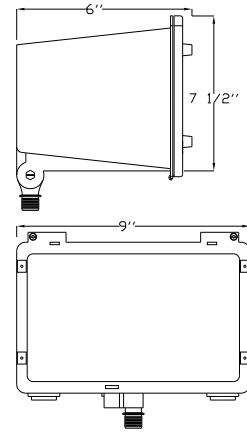

**Features:**

- Tempered Clear Glass Lens
- Cast Aluminum Housing
- Textured Bronze Finish
- Hinged Front Housing for Easy Relamping
- Medium-Base Socket for HPS and MH Models
- Adjustable Knuckle
- Lamp Included in all Models
- Suitable for Wet Locations



Cat. No. : **HFL3-MH175-PS** (Pulse Start)  
**\*HFL3-MH175** **120~277V**  
 Ballast : 120/208/240/277V  
 Quad CWA HPF  
 Lamp : Metal Halide (MH) 175W,  
 11700 Lumens, 65 CRI Color Rendition

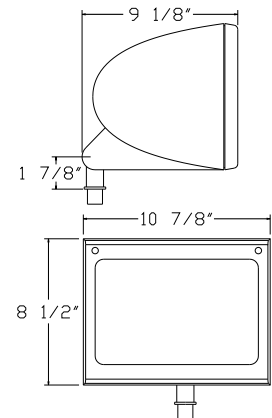

**Features:**

- **Round Back**
- Tempered Clear Glass Lens
- Cast Aluminum Housing
- Textured Bronze Finish
- Hinged Front Housing for Easy Relamping
- Medium-Base Socket
- Adjustable Knuckle
- Lamp Included
- Suitable for Wet Locations



\*While Supplies Last

Disclaimer: Shape, Design, and Finish may change without prior notice.





Cat. No. : **HFL2-MH175-PS** (Pulse Start)  
\***HFL2-MH175** 120~277V



Ballast : 120/208/240/277V Quad CWA HPF  
Lamp : Metal Halide (MH) 175W,  
11700 Lumens, 65 CRI Color Rendition

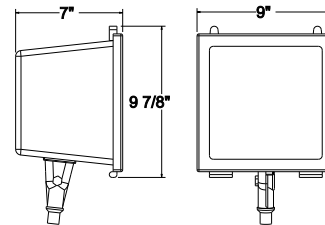

**Features:**

- **Standard Reflector**
- Tempered Clear Glass Lens
- Cast Aluminum Housing
- Textured Bronze Finish
- Hinged Front Housing for Easy Relamping
- Medium-Base Socket
- Adjustable Knuckle
- Lamp Included
- Suitable for Wet Locations



Cat. No. : **HFL2S-MH175-PS** (Pulse Start)  
\***HFL2S-MH175** 120~277V



Ballast : 120/208/240/277V Quad CWA HPF  
Lamp : Metal Halide (MH) 175W,  
11700 Lumens, 65 CRI Color Rendition

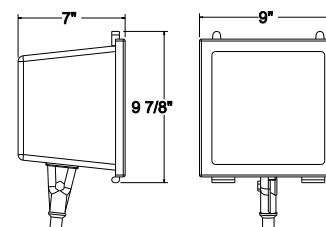

**Features:**

- **Spot Reflector**
- Tempered Clear Glass Lens
- Cast Aluminum Housing
- Textured Bronze Finish
- Hinged Front Housing for Easy Relamping
- Medium-Base Socket
- Adjustable Knuckle
- Lamp Included
- Suitable for Wet Locations



## Flood Lights

Cat. No. : **HFL4-HPS250** 120~277V

Ballast : 120/208/240/277V  
Quad Tap CWA HPF  
Lamp : High-Pressure Sodium (HPS) 250W,  
28000 Lumens, 22 CRI Color Rendition

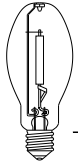

Cat. No. : **HFL4-HPS400** 120~277V

Ballast : 120/208/240/277V  
Quad Tap CWA HPF  
Lamp : High-Pressure Sodium (HPS) 400W,  
51000 Lumens, 22 CRI Color Rendition

Cat. No. : **HFL4-MH250-PS** (Pulse Start)

\* **HFL4-MH250** 120~277V

Ballast : 120/208/240/277V  
Quad Tap CWA HPF  
Lamp : Metal Halide (MH) 250W,  
19100 Lumens, 65 CRI Color Rendition

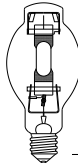

Cat. No. : **HFL4-MH400-PS** (Pulse Start)

\* **HFL4-MH400** 120~277V

Ballast : 120/208/240/277V  
Quad Tap CWA HPF  
Lamp : Metal Halide (MH) 400W,  
33100 Lumens, 65 CRI Color Rendition

Cat. No. : **FGS-4**

Description : Optional Glare Shield for HFL4  
Stamped Aluminum

Cat. No. : **SF-HFL**

Description : Cast Aluminum, Adjustable Slip-Fitter  
For use with : 250W and 400W HID Floodlights,  
Fits over 2-3/8" O.D. pipe  
Features : Sturdy Die-Cast Aluminum with dark-  
bronze polyester powder-coat finish,  
180° Adjustability,  
Mounting Bolts included

### Exclusive Design

Mounts Externally  
No Need to Open the Fixture

Cat. No. : **PM-HFL**

Description : Cast Aluminum Pole Mounting Arm  
For use with : 250W and 400W HID Floodlights  
Features : Sturdy Die-Cast Aluminum with dark-  
bronze polyester powder-coat finish,  
180° Adjustability,  
Gaskets and Mounting Bolts Included

Cat. No. : **PMA-HFL**

Description : Cast Aluminum Pole Mounting Arm  
For use with : 250W and 400W HID Floodlights  
Features : Adjustable Direct Pole Mount Arm

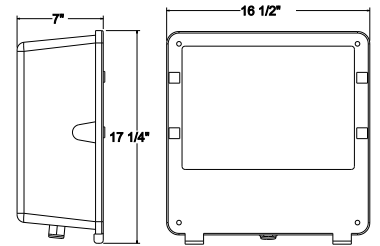

#### Features:

- Tempered Clear Glass Lens
- Cast Aluminum Housing
- Textured Bronze Finish
- Hinged Front Housing for Easy Relamping
- Mogul-Base Sockets
- Mounting Yoke
- Lamp Included in all Models
- Suitable for Wet Locations



Shown Installed

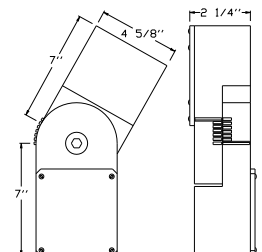
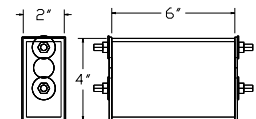
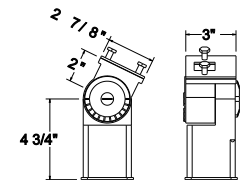

\*While Supplies Last

Disclaimer: Shape, Design, and Finish may change without prior notice.

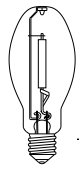

Cat. No. : **HFL5-HPS250** 120~277V  
 Ballast : 120/208/240/277V  
 Quad Tap CWA HPF  
 Lamp : High-Pressure Sodium (HPS) 250W,  
 28000 Lumens, 22 CRI Color Rendition

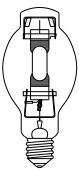

Cat. No. : **HFL5-HPS400** 120~277V  
 Ballast : 120/208/240/277V  
 Quad Tap CWA HPF  
 Lamp : High-Pressure Sodium (HPS) 400W,  
 51000 Lumens, 22 CRI Color Rendition

Cat. No. : **HFL5-MH250-PS** (Pulse Start)  
**\*HFL5-MH250** 120~277V

Ballast : 120/208/240/277V  
 Quad Tap CWA HPF  
 Lamp : Metal Halide (MH) 250W,  
 19100 Lumens, 65 CRI Color Rendition

Cat. No. : **HFL5-MH400-PS** (Pulse Start)  
**\*HFL5-MH400** 120~277V

Ballast : 120/208/240/277V  
 Quad Tap CWA HPF  
 Lamp : Metal Halide (MH) 400W,  
 33100 Lumens, 65 CRI Color Rendition

Cat. No. : **FGS-5**  
 Description : Optional Glare Shield HFL6  
 Stamped Aluminum



Shown Installed

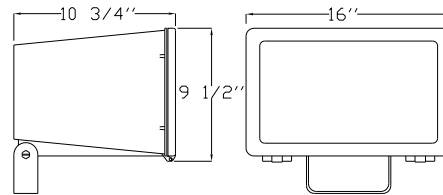

**Features:**

- Tempered Clear Glass Lens
- Cast Aluminum Housing
- Textured Bronze Finish
- Hinged Front Housing for Easy Relamping
- Mogul-Base Sockets
- Mounting Yoke
- Lamp Included in all Models
- Suitable for Wet Locations



Cat. No. : **HL38-MH70** 120~277V  
 Ballast : 120/208/240/277V, Quad Tap HX NPF  
 Lamp : Metal Halide (MH) 70W Included,  
 5500 Lumens, 65 CRI Color Rendition

Cat. No. : **HL38-MH100** 120~277V  
 Ballast : 120/208/240/277V, Quad Tap HX NPF  
 Lamp : Metal Halide (MH) 100W Included,  
 6200 Lumens, 65 CRI Color Rendition

Available Finishes (For **HL38** Fixture):  
 Black, Bronze, Green, White



HL38-MH70  
 HL38-MH100

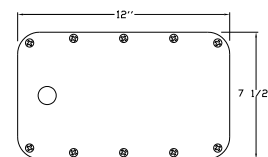
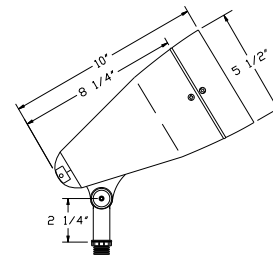

UGJB

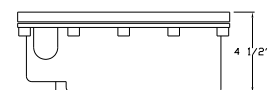

Cat. No. : **UGJB**  
 Description : Optional Fiberglass Underground  
 Junction Box Without Ballast Gear

\*While Supplies Last

Disclaimer: Shape, Design, and Finish may change without prior notice.

[www.orbitelectric.com](http://www.orbitelectric.com)

# Ceiling Mount Lights

Cat. No. : **HCM1-MH175-PS** (Pulse Start)  
**\*HCM1-MH175** 120~277V

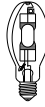

Ballast : 120/208/240/277V  
 Quad Tap CWA HPF  
 Lamp : Metal Halide (MH) 175W,  
 11700 Lumens, 65 CRI Color Rendition

Cat. No. : **HCM1-HPS150 120V**

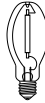

Ballast : 120V NPF  
 Lamp : High-Pressure Sodium (HPS) 150W,  
 16000 Lumens, 22 CRI Color Rendition

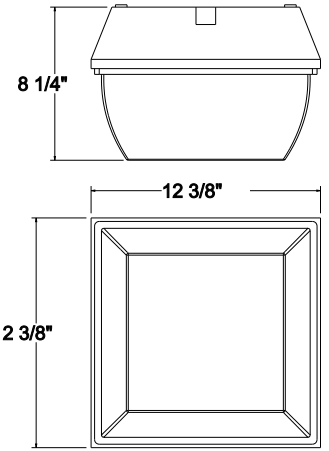

**Features:**

- Polycarbonate Lens
- Cast Aluminum Housing
- Textured Bronze Finish
- Medium-Base Socket
- Lamp Included in both Models
- Suitable for Damp Locations



Cat. No. : **HCM2-MH175-PS** (Pulse Start)  
**\*HCM2-MH175** 120~277V



Ballast : 120/208/240/277V  
 Quad Tap CWA HPF  
 Lamp : Metal Halide (MH) 175W,  
 11700 Lumens, 65 CRI Color Rendition

Cat. No. : **HCM2-HPS150 120V**



Ballast : 120/208/240/277V NPF  
 Lamp : High-Pressure Sodium (HPS) 150W,  
 16000 Lumens, 22 CRI Color Rendition

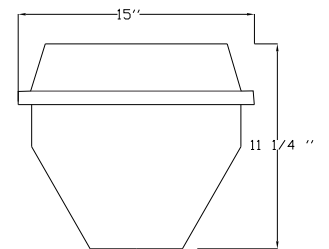

**Features:**

- Polycarbonate Lens
- Cast Aluminum Housing
- Textured Bronze Finish
- Medium-Base Socket
- Lamp Included in both Models
- Suitable for Damp Locations



H.I.D. Lighting

\*While Supplies Last

Disclaimer: Shape, Design, and Finish may change without prior notice.



# H34 Garage & Construction Lights



Cat. No. : **HCM3-MH175-PS** (Pulse Start)  
**\*HCM3-MH175** 120~277V



Ballast : 120/208/240/277V  
 Quad Tap CWA HPF  
 Lamp : Metal Halide (MH) 175W,  
 11700 Lumens, 65 CRI Color Rendition

Cat. No. : **HCM3-HPS150** 120~277V



Ballast : 120/208/240/277V Quad CWA  
 Lamp : High-Pressure Sodium (HPS) 150W,  
 16000 Lumens, 22 CRI Color Rendition

Cat. No. : **HCM3-PL84** 120/277V

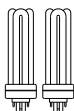

Ballast : 120/277V Electronic  
 Lamp : 2 X PL42 (4-Pin, GX24Q-4 Socket) 42W,  
 6000 Lumens, 82 CRI Color Rendition

Cat. No. : **HCM3-PL168** 120/277V

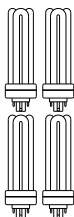

Ballast : 120/277V Electronic  
 Lamp : 2 X PL42 (4-Pin, GX24Q-4 Socket) 42W,  
 12000 Lumens, 82 CRI Color Rendition

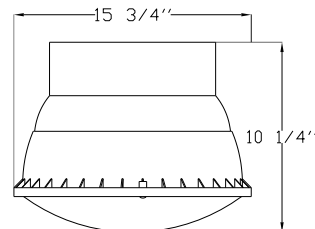

**Features:**

- Deluxe Garage Light
- Remove Upper Aluminum Reflector Band to Illuminated Ceiling
- Round Cast Aluminum Housing
- Clear Polycarbonate Reflector
- Easy-Hang Bracket fits Standard 4-Inch Electrical Box
- Cast Aluminum Housing
- Medium-Base Socket for HPS & MH Models
- Lamp Included
- Suitable for Damp Locations



H.I.D. Lighting

Cat. No. : **HHB1-MH400-PS** (Pulse Start)  
**\*HHB1-MH400** 120~277V

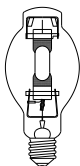

Ballast : 120/208/240/277V  
 Quad CWA HPF  
 Pre-Wired for 120 Volt  
 Lamp : Mogul Base 400W Metal Halide Lamp Incl.  
 33100 Lumens, 82 CRI Color Rendition

**NEC 2005 Features:**

- Complies with NEC 2005 for Open-Rated (Pink) Socket
- Includes Open-Rated EX39 Lamp

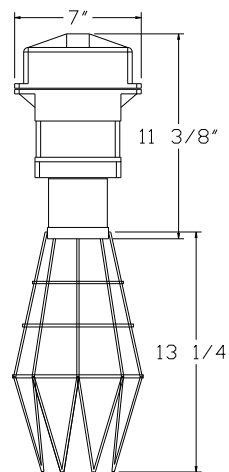

**Features:**

- High-Bay Light with Wire Guard
- Hook & Plug-In Cord Installed
- Prewired for 120V
- Cast Aluminum Construction
- Adjustable Reflector Bracket to Control Light Angle
- Chrome Steel Wire Guard
- Custom Molded Packaging Protects Fixture on the Job Site



\*While Supplies Last

Disclaimer: Shape, Design, and Finish may change without prior notice.

[www.orbitelectric.com](http://www.orbitelectric.com)

# High/Low Bay Ballasts

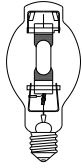

Cat. No. : **HHB2-MH250-PS** (Pulse Start)  
 \* **HHB2-MH250**  
**HHB2-MH400-PS** (Pulse Start)  
 \* **HHB2-MH400** 120~277V

Ballast : 120/208/240/277V, Quad Tap CWA HPF  
 Lamp : Mogul Base Metal Halide Lamp Included  
 Wattage : 250W or 400W, See Cat. Numbers Above

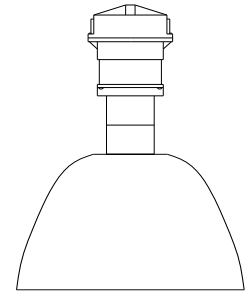

Assembly Drawing Only

*Order Dome and Accessories Separately.*

## HIGH/LOW BAY DOMES

ALL DOMES CAN ACCOMMODATE ACCESSORIES ON FOLLOWING PAGE

Cat. No.	Description
HHB2-AR16	16" Aluminum Reflector Dome
HHB2-AR22	22" Aluminum Reflector Dome
HHB2-AR16WH	16" White Powder-Coated Aluminum Reflector Dome
HHB2-AR22WH	22" White Powder-Coated Aluminum Reflector Dome
HHB2-ACR16	16" Prismatic Acrylic Reflector Dome, Requires <b>HHB2-CO16</b> Collar for installation
HHB2-ACR22	22" Prismatic Acrylic Reflector Dome, Requires <b>HHB2-CO22</b> Collar for installation



HHB2-AR16



HHB2-AR22



HHB2-AR16WH



HHB2-AR22WH



HHB2-ACR16



HHB2-ACR22

\*While Supplies Last

Disclaimer: Shape, Design, and Finish may change without prior notice.



**HIGH/LOW BAY ACCESSORIES**

**ALL ACCESSORIES CAN BE USED WITH EITHER ALUMINUM OR ACRYLIC DOMES**



SCS-75

See page A5 for more details



SCR-75

Cat. No.	Description
<b>SCS-75</b>	Swivel Cover for Square Box, 3/4" Hub with 1/2" Reducing Bushing
<b>SCR-75</b>	Swivel Cover for Round Box, 3/4" Hub with 1/2" Reducing Bushing
<b>HHB2-GL16</b>	16" Tempered Glass Lens with Rubber Gasket (Clamp Band Required for Installation, Sold Separately)
<b>HHB2-GL22</b>	22" Tempered Glass Lens with Rubber Gasket (Clamp Band Required for Installation, Sold Separately)
<b>HHB2-WG16</b>	16" Wire Guard
<b>HHB2-WG22</b>	22" Wire Guard
<b>HHB2-ACDL16</b>	16" Acrylic Drop Lens (Clamp Band Required for Installation, Sold Separately)
<b>HHB2-ACDL22</b>	22" Acrylic Drop Lens (Clamp Band Required for Installation, Sold Separately)
<b>HHB2-CB16</b>	16" Clamp Band
<b>HHB2-CB22</b>	22" Clamp Band
<b>HHB2-CO16</b>	Collar for 16" Prismatic Dome
<b>HHB2-CO22</b>	Collar for 22" Prismatic Dome



HHB2-GL16



HHB2-GL22

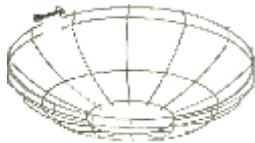

HHB2-WG16

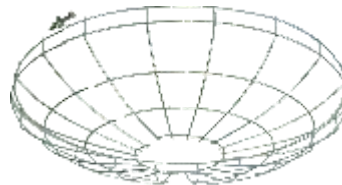

HHB2-WG22



HHB2-ACDL16



HHB2-ACDL22



HHB2-CB16



HHB2-CB22



HHB2-CO16



HHB2-CO22

H.I.D. Lighting

Disclaimer: Shape, Design, and Finish may change without prior notice.

[www.orbitelectric.com](http://www.orbitelectric.com)

## Emergency Ballasts/ Under Cabinet Lights

### FLUORESCENT EMERGENCY LIGHTING BALLASTS

- 120/277 VAC, Fully Automatic Operation
- 280mA Charging current
- 24Hr Recharging Time
- 90 minutes of emergency operation
- Wireway or Fixture Mount
- Battery, Charger, Inverter Circuit in a Single Package
- **For more information see page F18**



BAL650C



BAL500



BAL700





BAL1400



BAL3000

### FLUORESCENT EMERGENCY LIGHTING BALLASTS LAMP COMPATIBILITY CHART

For more information see page F19

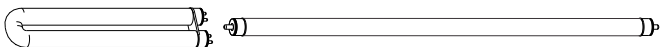
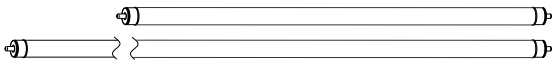
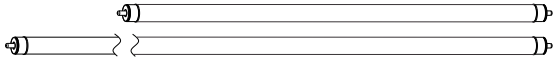
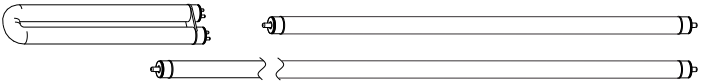
Cat. No.	Description
<b>BAL650C-2PIN</b>	For 2-Pin Compact Fluorescent Lamp Operates One 13W - 42W or Two 13W - 39W Twin, Quad Lamps 
<b>BAL650C-4PIN</b>	For 4-Pin Compact Fluorescent Lamp Operates One 13W - 42W or Two 13W - 39W Twin, Quad, Triple-Twin, Long Compact or 2D Lamps 
<b>BAL500</b>	Operates One 17W - 40W (2' - 4') T8, T10, or T12 Lamp 
<b>BAL700</b>	Operates One 17W - 215W (2' - 8'), or Two 17W - 40W (2' - 4') T8, T9, T10, or T12 Lamps 
<b>BAL1400</b>	Operates One 17W - 215W (2' - 8'), or Two 17W - 40W (2' - 4') T8, T9, T10, or T12 Lamps 
<b>BAL3000</b>	Operates One of: F025, FB024 T8, F032, FB031 T8, F096 T8, F017, FB016, F40T12, F40/U, F48T12/HO, F96T12, HO, VHO  Or Two of: F025, FB024 T8, F032, FB031 T8, F017, FB016, F40T12, F40/U

### UNDER CABINET LIGHTS

- 120~125 VAC
- T5 Fluorescent Lamp
- Electronic Class P Ballast
- Turn Switch Included
- Heavy Gage Steel with Flush Ends
- K.O.s on Top, Sides, and Back
- Baked white enamel
- With Rust Inhibiting Phosphate Coat
- **For more information see page F20**



UCL-12



UCL-21



UCL-24



UCL-33



UCL-42

Disclaimer: Shape, Design, and Finish may change without prior notice.

[www.orbitelectric.com](http://www.orbitelectric.com)





# Ballasts Kits

Cat. No.	Type	WATTS	DESCRIPTION	VOLTS
BAL50HPSKIT	High Pressure Sodium	50 Non UL	Ballast & Ignitor	120
BAL70HPSKIT	High Pressure Sodium	70	Ballast & Ignitor	120
BAL150HPSKIT	High Pressure Sodium	150	Ballast & Ignitor	120
BAL250HPSKIT	High Pressure Sodium	250	Ballast, Capacitor, & Ignitor	120/208/240/277
BAL400HPSKIT	High Pressure Sodium	400	Ballast, Capacitor, & Ignitor	120/208/240/277
BAL70MHKIT	Metal Halide	70	Ballast, Capacitor, & Ignitor	120/208/240/277
BAL100MHKIT	Metal Halide	100	Ballast, Capacitor, & Ignitor	120/208/240/277
BAL175MHKIT	Metal Halide	175	Ballast & Capacitor	120/208/240/277
BAL250MHKIT	Metal Halide	250	Ballast & Capacitor	120/208/240/277
BAL400MHKIT	Metal Halide	400	Ballast & Capacitor	120/208/240/277



Line Voltage

Disclaimer: Shape, Design, and Finish may change without prior notice.

[www.orbitelectric.com](http://www.orbitelectric.com)

# LED Lamps

Cat. No.	Description	Voltage	Wattage	Base	Kelvin Rating	Life (Hrs.)	Std. Pkg.
<b>MR16-3W-LED-BP</b>	MR16 LED, Flood	12V	3W	GZ6.35 (2-Pin)	3500-4200	50,000	10
<b>MR16-3W-LED-EB</b>	MR16 LED, Flood	120V	3W	Edison Base	3500-4200	50,000	10
<b>R10-7W-LED</b>	LED Light Bulb	120V	7W	Edison Base	3500-4200	50,000	10
<b>R20-9W-LED</b>	LED PAR20 Flood Light	120V	9W	Edison Base	3500-4200	50,000	10
<b>R30-13W-LED</b>	LED PAR30 Flood Light	120V	13W	Edison Base	3500-4200	50,000	10
<b>DL8-12W-LED</b>	LED Light Bulb	120V	12W	Edison Base	3500-4200	50,000	10
<b>PXR-15W-LED</b>	T8 Replacement, 4 FT	120/277V	15W	-	3500-4200	50,000	10
<b>RF6-14W-LED</b>	6" Retrofit Kit	120V	14W	Retrofit	3500-4200	50,000	5



MR16-3W-LED-BP



MR16-3W-LED-EB



R10-7W-LED



R20-9W-LED



R30-13W-LED



DL8-12W-LED



PXR-15W-LED



RF6-14W-LED

H.I.D. Lighting

Disclaimer: Shape, Design, and Finish may change without prior notice.

[www.orbitelectric.com](http://www.orbitelectric.com)

